



# Wastel VAT-5

## 30/50/60 Liter / litres / litres

**Verwendungszweck**  
**Behältereigenschaften**

Zur Entsorgung von festen Abfällen aus dem medizinischen Bereich  
Zeitweiliger Verschluss und Endverschluss (Klickdeckel), durchstichfest,  
stapelbar, Kennzeichnung und Füllstandsanzeige, intelligente Aufhängung  
des Deckels während der Nutzung

**Motif de l'utilisation**  
**Caractéristiques du récipient**

Pour l'élimination des déchets solides provenant du secteur médical  
Fermetures temporaire et finale (couvercle clic), résistant à la perforation,  
empilable, étiquetage et indication du niveau de remplissage,  
suspension intelligente du couvercle pendant l'utilisation

**Purpose of use**  
**Container properties**

For the disposal of solid waste from the medical sector  
Temporary and final closure (click lid), puncture resistant, stackable,  
labelling and fill level indicator, smart suspension of the lid during use

# Wastel VAT-5

## 30/50/60 Liter / litres / litres

### Aussenmasse / Mesures extérieures / External dimensions:

<b>30 l</b>	404 mm (A)	334 mm (B)	315 mm (C)
<b>50 l</b>	404 mm (A)	334 mm (B)	517 mm (C)
<b>60 l</b>	404 mm (A)	334 mm (B)	646 mm (C)

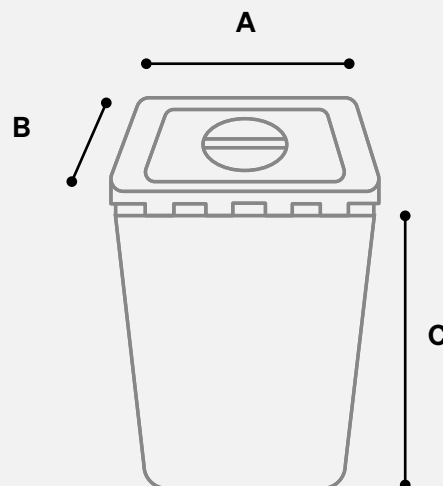

## Technische Angaben

<b>Material</b>	Polypropylen
<b>Grössen/Volumen</b>	30 l / 50 l / 60 l
<b>Farben</b>	Blau, schwarz, gelb, grün, rot, weiss, grau
<b>Verpackungsgruppe</b>	II und III (bzw. Y und Z)
<b>Prüfungen</b>	Bauartprüfung gemäss ADR, RID, IMDG, ICAO (UN-Zulassung), ISO 23907 / NF X 30-505 und NF X 30-511

## Caractéristiques techniques

<b>Matériel</b>	Polypropylène
<b>Tailles/volumes</b>	30 l / 50 l / 60 l
<b>Couleurs</b>	Bleu, noir, jaune, vert, rouge, blanc, gris
<b>Groupe d'emballage</b>	II et III (ou Y et Z)
<b>Tests</b>	Examen de type selon ADR, RID, IMDG, ICAO (homologation par l'ONU), ISO 23907 / NF X 30-505 et NF X 30-511

## Technical specifications

<b>Material</b>	Polypropylene
<b>Sizes/volumes</b>	30 l / 50 l / 60 l
<b>Colours</b>	Blue, black, yellow, green, red, white, grey
<b>Packing group</b>	II and III (or Y and Z)
<b>Test</b>	Type approval according to ADR, RID, IMDG, ICAO (UN approval), ISO 23907 / NF X 30-505 and NF X 30-511

## Zubehör

Pedalgestell aus Edelstahl  
(zwei oder vier Räder)  
Griffdeckel  
Klickdeckel  
Flachdeckel  
Steriliddeckel (für die Anwendung im Autoklav; 134 °C)

## Accessoires

Support à pédale en inox  
(deux ou quatre roues)  
Couvercle avec poignée  
Couvercle clic  
Couvercle plat  
Couvercle sterilid (pour l'utilisation en autoclave; 134 °C)

## Accessories

Stainless steel pedal frame  
(two or four wheels)  
Grip lid  
Click lid  
Flat lid  
Sterilid lid (for use in autoclaves; 134 °C)

**Max. Füllgewicht** (gemäss Bauartzu-  
lassung bzw. UN-Prüfung):  
**Poids max. de remplissage**  
(respectivement selon l'homologation  
de type et l'homologation par l'ONU):  
**Max. filling weight** (according to type  
approval and UN test, respectively):

<b>30 l</b>	15 kg	VG II bzw./ou/or Y
<b>50 l</b>	25 kg	VG II bzw./ou/or Y
<b>60 l</b>	25 kg	VG II bzw./ou/or Y

**Stückzahl pro Palette:**  
**Pièces par palette:**  
**Quantity per pallet:**

<b>30 l</b>	324
<b>50 l</b>	288
<b>60 l</b>	261
<b>Klickdeckel</b> <b>Couvercle clic</b> <b>Click lid</b>	486
<b>Griffdeckel</b> <b>Couvercle avec poignée</b> <b>Grip lid</b>	648
<b>Flachdeckel</b> <b>Couvercle plat</b> <b>Flat lid</b>	891
<b>Steriliddeckel</b> <b>Couvercle sterilid</b> <b>Sterilid lid</b>	216

**Artikelnummer / Numéro d'article / Item number:**

	<b>Wastel VAT-5 30 l</b>	blau / bleu / blue	2001v5
		schwarz / noir / black	2006v5
		gelb / jaune / yellow	2009v5
		rot / rouge / red	2014v5
		grün / vert / green	2012v5
		weiss / blanc / white	2017v5

	<b>Wastel VAT-5 30 l ohne Etikette sans autocollant without labelling</b>	blau / bleu / blue	2001Rv5
		schwarz / noir / black	2006Rv5
		gelb / jaune / yellow	2009Rv5
		rot / rouge / red	2014Rv5
		grün / vert / green	2012Rv5
		weiss / blanc / white	2017Rv5





	<b>Wastel VAT-5 50 l</b>	blau / bleu / blue	2002v5
		schwarz / noir / black	2007v5
		gelb / jaune / yellow	2010v5
		rot / rouge / red	2013v5
		grün / vert / green	2023v5
		weiss / blanc / white	2018v5
		grau / gris / grey	2021v5

	<b>Wastel VAT-5 50 l ohne Etikette sans autocollant without labelling</b>	blau / bleu / blue	2002Rv5
		schwarz / noir / black	2007Rv5
		gelb / jaune / yellow	2010Rv5
		rot / rouge / red	2005Rv5
		grün / vert / green	2023Rv5
		weiss / blanc / white	2018Rv5
		grau / gris / grey	2021Rv5

	<b>Wastel VAT-5 60 l</b>	blau / bleu / blue	2003v5
		schwarz / noir / black	2008v5
		gelb / jaune / yellow	2011v5
		rot / rouge / red	2016v5
		grün / vert / green	2005v5
		weiss / blanc / white	2019v5
		grau / gris / grey	2022v5

	<b>Wastel VAT-5 60 l ohne Etikette sans autocollant without labelling</b>	blau / bleu / blue	2003Rv5
		schwarz / noir / black	2008Rv5
		gelb / jaune / yellow	2011Rv5
		rot / rouge / red	2016Rv5
		grün / vert / green	2024Rv5
		weiss / blanc / white	2019Rv5
		grau / gris / grey	2022Rv5

**Artikelnummer / Numéro d'article / Item number:**

<b>Klickdeckel</b> <b>Couvercle clic</b> <b>Click lid</b>		● gelb / jaune / yellow	2001.2v5
		● rot / rouge / red	2004.5v5
		● pink / rose / pink	2004.2v5
		● schwarz / noir / black	2006.7v5
<b>Griffdeckel</b> <b>Couvercle avec poignée</b> <b>Grip lid</b>		● gelb / jaune / yellow	2001.3v5
		● rot / rouge / red	2004.4v5
		● pink / rose / pink	2004.6v5
		● orange / orange / orange	2004.8v5
		● weiss / blanc / white	2004.7v5
		● schwarz / noir / black	2006.6v5
<b>Griffdeckel ohne Haken und Dichtung</b> <b>Couvercle avec poignée sans crochet ni joint</b> <b>Grip lid without hook and seal</b>		● rot / rouge / red	2001.6v5
<b>Flachdeckel</b> <b>Couvercle plat</b> <b>Flat lid</b>		● gelb / jaune / yellow	2001.1v5
		● rot / rouge / red	2004.1v5
		● schwarz / noir / black	2006.1v5
<b>Steriliddeckel</b> <b>Couvercle sterilid</b> <b>Sterilid lid</b>		● orange / orange / orange	2056v5

**Artikelnummer / Numéro d'article / Item number:**

<b>Pedalgestell</b> <b>Support à pédale</b> <b>Stainless steel pedal frame</b> <b>2 Räder / roues / wheels</b>  2000.1v5	<b>Pedalgestell</b> <b>Support à pédale</b> <b>Stainless steel pedal frame</b> <b>4 Räder / roues / wheels</b>  2000.v5	<b>Pedalgestell klein</b> <b>Support à pédale petit</b> <b>Stainless steel pedal frame small</b> <b>2 Räder / roues / wheels</b>  2000KL
	